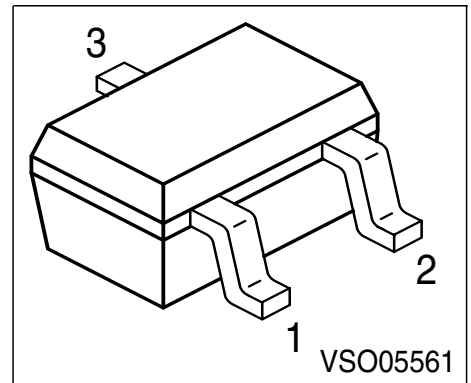
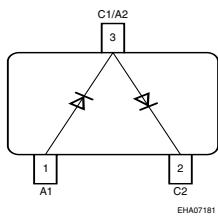
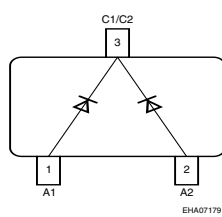
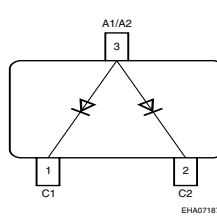

**Silicon PIN Diode**

- PIN diode for high speed switching of RF signal
- Low forward resistance
- Very low capacitance
- For frequencies up to 3 GHz

**BAR 63-04W**

**BAR 63-05W**

**BAR 63-06W**

Type	Marking	Pin Configuration			Package
		1	2	3	
BAR 63-04W	G4s	1 = A1	2 = C2	3=C1/A2	SOT-323
BAR 63-05W	G5s	1 = A1	2 = A2	3 = C1/2	SOT-323
BAR 63-06W	G6s	1 = C1	2 = C2	3 = A1/2	SOT-323

**Maximum Ratings**

Parameter	Symbol	Value	Unit
Diode reverse voltage	$V_R$	50	V
Forward current	$I_F$	100	mA
Total power dissipation, $T_S \leq 105\text{ }^\circ\text{C}$	$P_{tot}$	250	mW
Junction temperature	$T_j$	150	°C
Operating temperature range	$T_{op}$	-55 ... 150	
Storage temperature	$T_{stg}$	-55 ... 150	

**Thermal Resistance**

Junction - ambient <sup>1)</sup>	$R_{thJA}$	$\leq 340$	K/W
Junction - soldering point	$R_{thJS}$	$\leq 180$	

1) Package mounted on alumina 15mm x 16.7mm x 0.7mm

**Electrical Characteristics** at  $T_A = 25^\circ\text{C}$ , unless otherwise specified.

Parameter	Symbol	Values			Unit
		min.	typ.	max.	
<b>DC characteristics</b>					
Breakdown voltage $I_{(BR)} = 5 \mu\text{A}$	$V_{(BR)}$	50	-	-	V
Reverse current $V_R = 20 \text{ V}$	$I_R$	-	-	50	nA
Forward voltage $I_F = 100 \text{ mA}$	$V_F$	-	0.95	1.2	V
<b>AC characteristics</b>					
Diode capacitance $V_R = 0 \text{ V}, f = 100 \text{ MHz}$ $V_R = 5 \text{ V}, f = 1 \text{ MHz}$	$C_T$	- -	0.3 0.21	- 0.3	pF
Forward resistance $I_F = 5 \text{ mA}, f = 100 \text{ MHz}$ $I_F = 10 \text{ mA}, f = 100 \text{ MHz}$	$r_f$	- -	1.2 1	2 -	$\Omega$
Charge carrier life time $I_F = 10 \text{ mA}, I_R = 6 \text{ mA}, I_R = 3 \text{ mA}$	$\tau_{rr}$	-	75	-	ns
Series inductance	$L_S$	-	1.4	-	nH

**Forward current  $I_F = f(T_A^*; T_S)$**

\* mounted on alumina

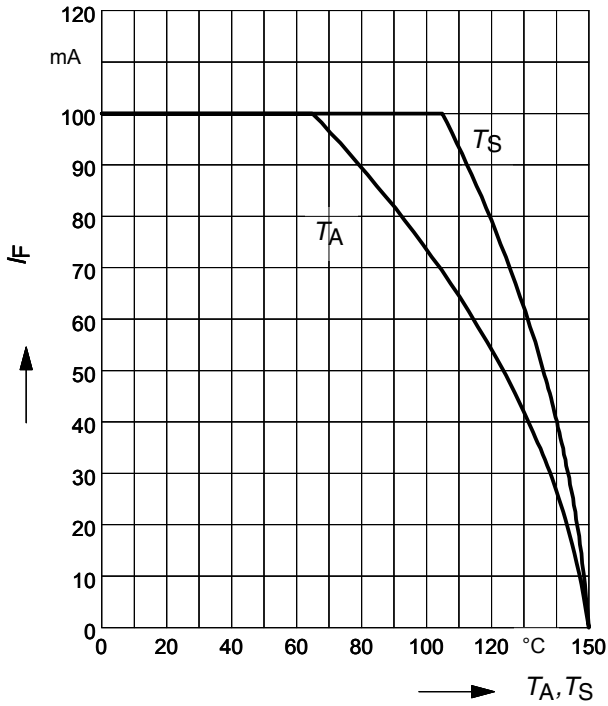

**Permissible Pulse Load  $R_{thJS} = f(t_p)$**

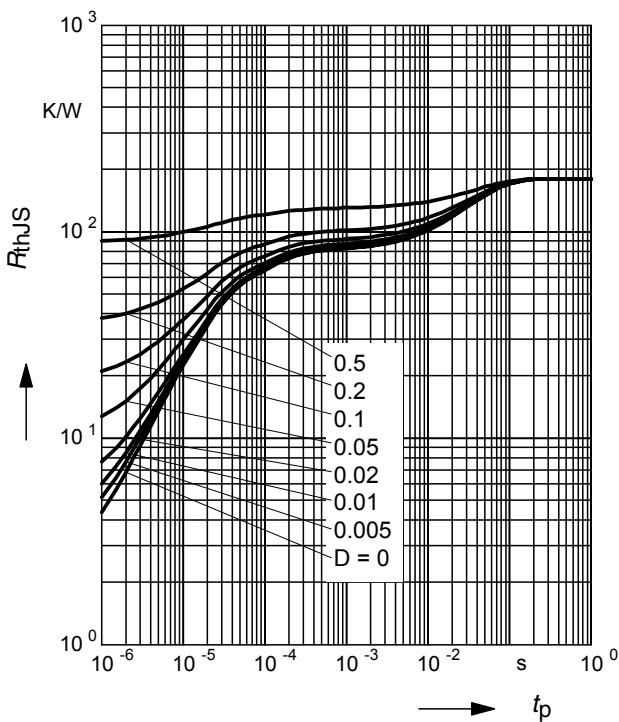

**Permissible Pulse Load**

$I_{Fmax} / I_{FDC} = f(t_p)$

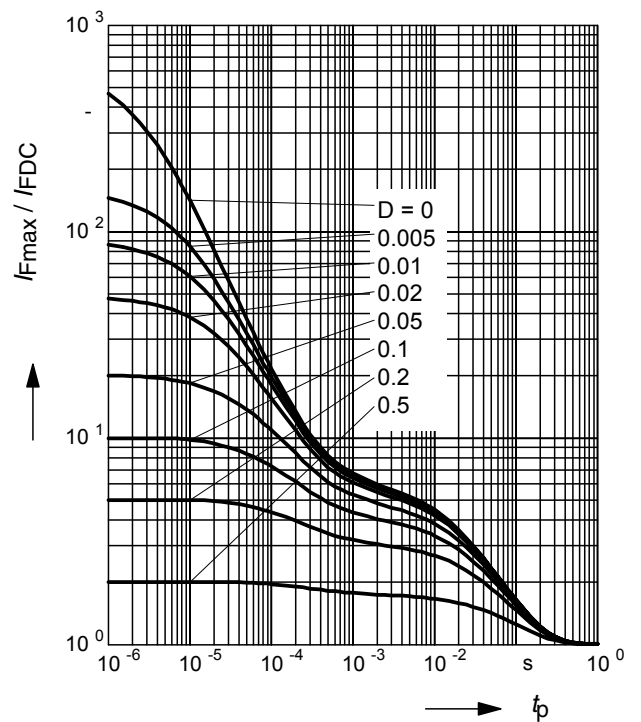

**Diode capacitance  $C_T = f(V_R)$**

$f = 1\text{MHz}$

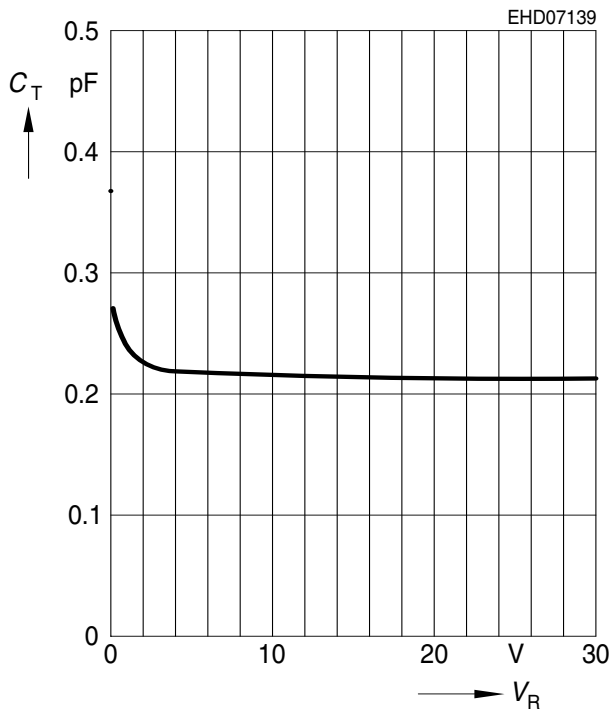

**Forward resistance  $r_f = f(I_F)$**

$f = 100\text{MHz}$

