

## LM2941C 1A Low Dropout Adjustable Regulator

### General Description

The LM2941C positive voltage regulator features the ability to source 1A of output current with a typical dropout voltage of 0.5V and a maximum of 1V over the entire temperature range. Furthermore, a quiescent current reduction circuit has been included which reduces the ground pin current when the differential between the input voltage and the output voltage exceeds approximately 3V. The quiescent current with 1A of output current and an input-output differential of 5V is therefore only 30 mA. Higher quiescent currents only exist when the regulator is in the dropout mode ( $V_{IN} - V_{OUT} \leq 3V$ ).

Low dropout voltage, coupled with 1A current capability, makes the LM2941C useful in applications where the input voltage is maintained at a level within one or two volts of the output voltage. Operation at these low input-output voltage differentials reduces regulator power dissipation and increases overall system efficiency.

The LM2941C can be used to provide on-board regulation and post-switcher regulation. Other applications include fault protected 1A switches.

### Features

- Output voltage adjustable from 5V to 20V
- Dropout voltage typically 0.5V @  $I_O = 1A$
- Output current in excess of 1A
- Trimmed reference voltage
- Reverse battery protection
- Internal short circuit current limit
- Mirror image insertion protection
- 100% electrical burn-in in thermal limit
- TTL, CMOS compatible ON/OFF switch

### Equivalent Schematic and Connection Diagram

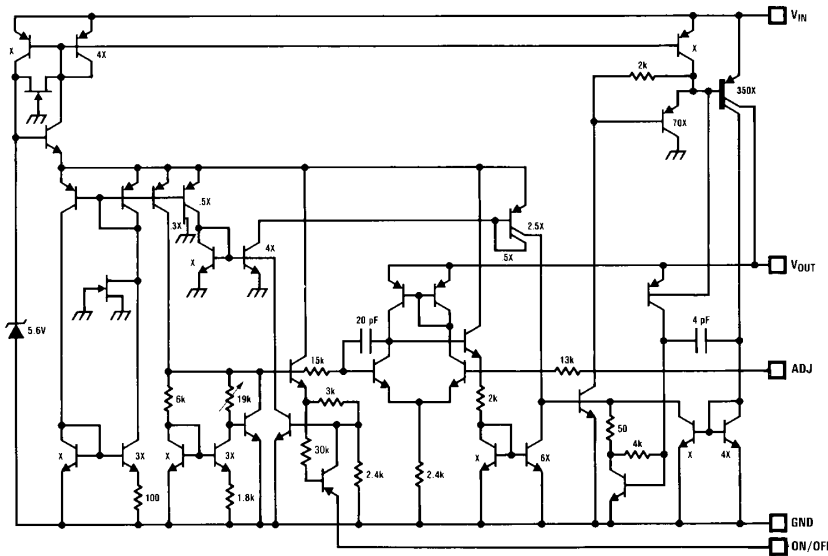

TL/H/10367-1

(TO-220)  
Plastic Package

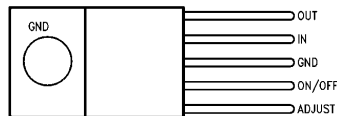

TL/H/10367-2

Front View  
Order Number LM2941CT  
See NS Package Number T05A

LM2941C 1A Low Dropout Adjustable Regulator

## Absolute Maximum Ratings

If Military/Aerospace specified devices are required, please contact the National Semiconductor Sales Office/Distributors for availability and specifications.

Input Voltage

Survival Voltage ( $\leq 100$ ms)	45V
Operational Voltage	26V

Internal Power Dissipation (Note 1) Internally limited

Operating Temperature Range ( $T_A$ )	$0^\circ\text{C}$ to $+125^\circ\text{C}$
Maximum Junction Temperature	$150^\circ\text{C}$
Storage Temperature Range	$-65^\circ\text{C}$ to $+150^\circ\text{C}$
Lead Temperature (Soldering, 10 seconds)	$260^\circ\text{C}$
ESD susceptibility rating is to be determined.	

## Electrical Characteristics

$5\text{V} \leq V_O \leq 20\text{V}$ ,  $V_{IN} = V_O + 5\text{V}$ ,  $C_O = 22 \mu\text{F}$ ,  $T_J = 25^\circ\text{C}$  (unless otherwise specified)

Parameter	Conditions	Typ	Tested Limit (Note 2)	Design Limit (Note 3)	Units (Limits)
Reference Voltage	$5\text{ mA} \leq I_O \leq 1\text{ A}$ , (Note 4)	1.275	1.237 1.313	1.211 1.339	V(min) V(max)
Line Regulation	$V_O + 2\text{V} \leq V_{IN} \leq 26\text{V}$ , $I_O = 5\text{ mA}$	4	10		mV/V(max)
Load Regulation	$50\text{ mA} \leq I_O \leq 1\text{ A}$	7	10		mV/V(max)
Output Impedance	100 mADC and 20 mArms $f_O = 120\text{ Hz}$	7			$\text{m}\Omega/\text{V}$
Quiescent Current	$V_O + 2\text{V} \leq V_{IN} < 26\text{V}$ , $I_O = 5\text{ mA}$	10	15		mA(max)
	$V_{IN} = V_O + 5\text{V}$ , $I_O = 1\text{ A}$	30	45	60	mA(max)
RMS Output Noise, % of $V_{OUT}$	10 Hz–100 kHz $I_O = 5\text{ mA}$	0.003			%
Ripple Rejection	$f_O = 120\text{ Hz}$ , 1 Vrms, $I_L = 100\text{ mA}$	0.005	0.02		%/V(max)
Long Term Stability		0.4			%/1000 Hr
Dropout Voltage	$I_O = 1\text{ A}$	0.5	0.8	1.0	V(max)
	$I_O = 100\text{ mA}$	110	200	200	mV(max)
Short Circuit Current	$V_{IN\text{ max}} = 26\text{V}$ (Note 5)	1.9	1.6		A(min)
Maximum Line Transient	$V_O$ max 1V above nominal $V_O$ $R_O = 100\Omega$ , $T \leq 100\text{ ms}$	55	45		V(min)
Maximum Operational Input Voltage		31	26		$V_{DC}$
Reverse Polarity DC Input Voltage	$R_O = 100\Omega$ , $V_O \geq -0.6\text{V}$	-30	-15		V(min)
Reverse Polarity Transient Input Voltage	$T \leq 100\text{ ms}$ , $R_O = 100\Omega$	-55	-45		V(min)
ON/OFF Threshold Voltage ON	$I_O \leq 1\text{ A}$	1.30	0.80		V(max)
ON/OFF Threshold Voltage OFF	$I_O \leq 1\text{ A}$	1.30	2.00		V(min)
ON/OFF Threshold Current	$V_{ON/OFF} = 2.0\text{V}$ $I_O \leq 1\text{ A}$	50	100		$\mu\text{A}$ (max)

**Note 1:** The maximum power dissipation is a function of  $T_{J(\text{max})}$ ,  $\theta_{JA}$  and  $T_A$ . The maximum allowable power dissipation at any ambient temperature is  $P_D = (T_{J(\text{max})} - T_A)/\theta_{JA}$ . If this dissipation is exceeded, the die temperature will rise above  $150^\circ\text{C}$  and the LM2941C will go into thermal shutdown. For the LM2941C, the junction-to-ambient thermal resistance is  $53^\circ\text{C}/\text{W}$ , and the junction-to-case thermal resistance is  $3^\circ\text{C}/\text{W}$ .

**Note 2:** Tested Limits are guaranteed and 100% production tested.

**Note 3:** Design Limits are guaranteed (but not 100% production tested) over the operating temperature and supply voltage range. These limits are not used to calculate outgoing quality levels.

**Note 4:** The output voltage range is 5V to 20V and is determined by the two external resistors, R1 and R2. See Typical Application Circuit.

**Note 5:** Output current will decrease with increasing temperature, but will not go below 1A at the maximum specified temperatures.

# Typical Performance Characteristics

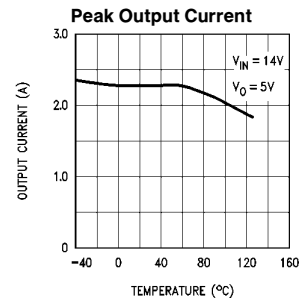
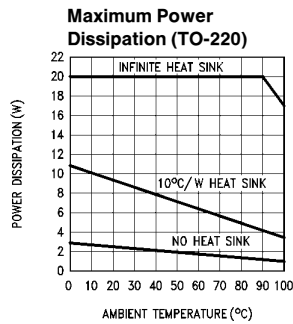
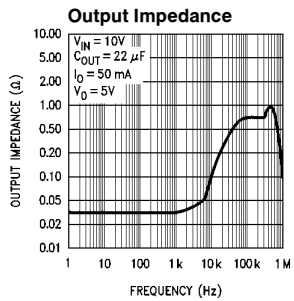
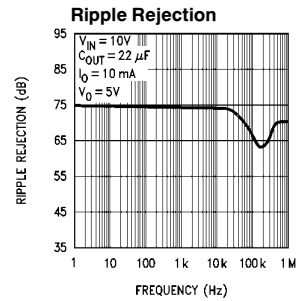
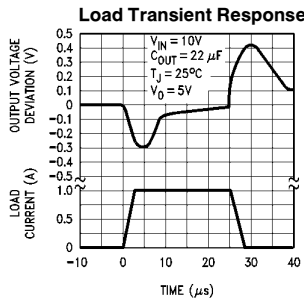
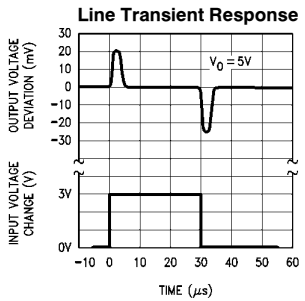
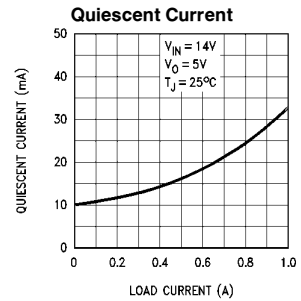
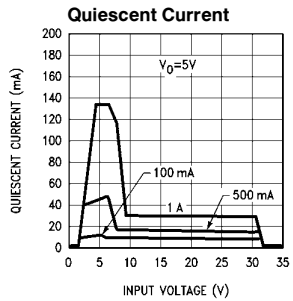
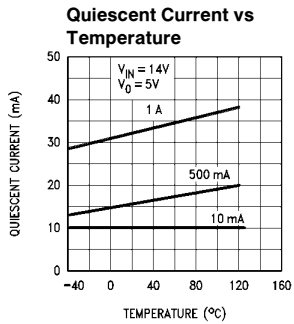
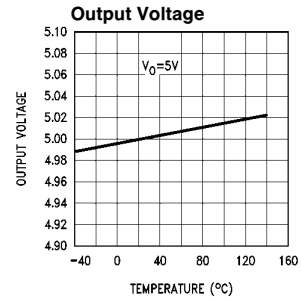
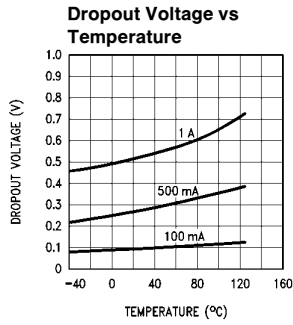
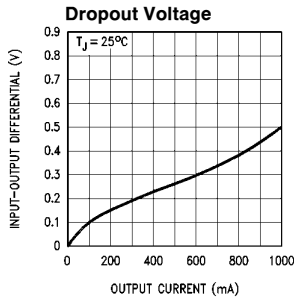

TL/H/10367-3

## Typical Performance Characteristics (Continued)

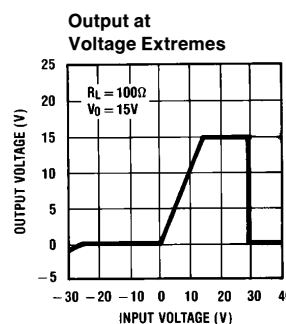
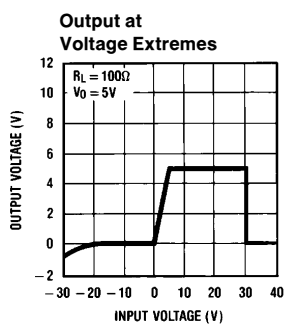
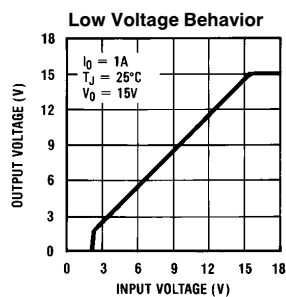
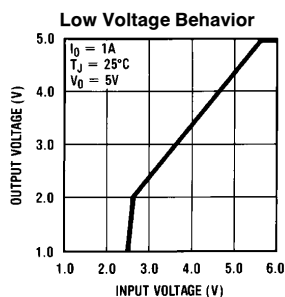

TL/H/10367-4

## Definition of Terms

**Dropout Voltage:** The input-voltage differential at which the circuit ceases to regulate against further reduction in input voltage. Measured when the output voltage has dropped 100 mV from the nominal value obtained at ( $V_{OUT} + 5V$ ) input, dropout voltage is dependent upon load current and junction temperature.

**Input Voltage:** The DC voltage applied to the input terminals with respect to ground.

**Input-Output Differential:** The voltage difference between the unregulated input voltage and the regulated output voltage for which the regulator will operate.

**Line Regulation:** The change in output voltage for a change in the input voltage. The measurement is made under conditions of low dissipation or by using pulse techniques such that the average chip temperature is not significantly affected.

**Load Regulation:** The change in output voltage for a change in load current at constant chip temperature.

**Long Term Stability:** Output voltage stability under accelerated life-test conditions after 1000 hours with maximum rated voltage and junction temperature.

**Output Noise Voltage:** The rms AC voltage at the output, with constant load and no input ripple, measured over a specified frequency range.

**Quiescent Current:** That part of the positive input current that does not contribute to the positive load current. The regulator ground lead current.

**Ripple Rejection:** The ratio of the peak-to-peak input ripple voltage to the peak-to-peak output ripple voltage.

**Temperature Stability of  $V_O$ :** The percentage change in output voltage for a thermal variation from room temperature to either temperature extreme.

## Typical Applications

### 5V to 20V Adjustable Regulator

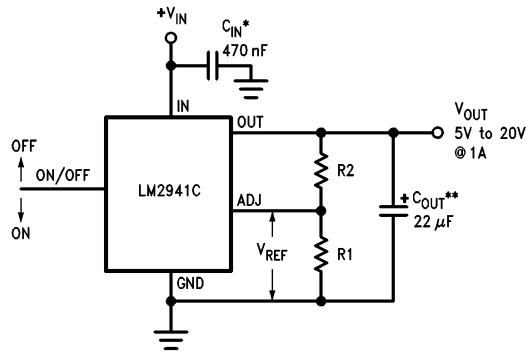

TL/H/10367-5

$$V_{OUT} = \text{Reference voltage} \times \frac{R1 + R2}{R1} \text{ where } V_{REF} = 1.275 \text{ typical}$$

$$\text{Solving for } R2: R2 = R1 \left( \frac{V_O}{V_{REF}} - 1 \right)$$

**Note:** Using 1k for R1 will ensure that the input bias current error of the adjust pin will be negligible. Do not bypass R1 or R2. This will lead to instabilities.

\*Required if regulator is located far from power supply filter.

\*\*C<sub>OUT</sub> must be at least 22 μF to maintain stability. May be increased without bound to maintain regulation during transients. Locate as close as possible to the regulator. This capacitor must be rated over the same operating temperature range as the regulator and should have an ESR less than 1Ω to maintain stability.

### 1A Switch

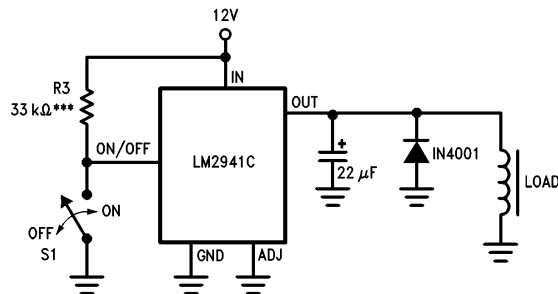

TL/H/10367-6

\*\*\*To assure shutdown, select resistor R3 to guarantee at least 300 μA of pull-up current when S1 is open. (Assume 2V at the ON/OFF pin.)

**Physical Dimensions** inches (millimeters) unless otherwise noted

Lit. # 108023

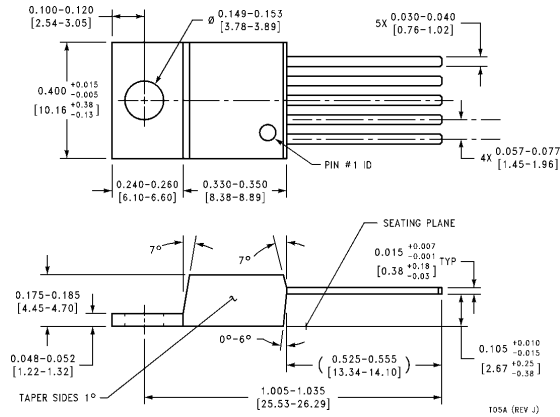

**5-Lead Molded TO-220 (T)  
Order Number LM2941CT  
NS Package Number T05A**

**LIFE SUPPORT POLICY**

NATIONAL'S PRODUCTS ARE NOT AUTHORIZED FOR USE AS CRITICAL COMPONENTS IN LIFE SUPPORT DEVICES OR SYSTEMS WITHOUT THE EXPRESS WRITTEN APPROVAL OF THE PRESIDENT OF NATIONAL SEMICONDUCTOR CORPORATION. As used herein:

1. Life support devices or systems are devices or systems which, (a) are intended for surgical implant into the body, or (b) support or sustain life, and whose failure to perform, when properly used in accordance with instructions for use provided in the labeling, can be reasonably expected to result in a significant injury to the user.
2. A critical component is any component of a life support device or system whose failure to perform can be reasonably expected to cause the failure of the life support device or system, or to affect its safety or effectiveness.



**National Semiconductor Corporation**  
1111 West Bardin Road  
Arlington, TX 76017  
Tel: 1(800) 272-9959  
Fax: 1(800) 737-7018

<http://www.national.com>

**National Semiconductor Europe**

Fax: +49 (0) 180-530 85 86  
Email: [europe.support@nsc.com](mailto:europe.support@nsc.com)  
Deutsch Tel: +49 (0) 180-530 85 85  
English Tel: +49 (0) 180-532 78 32  
Français Tel: +49 (0) 180-532 93 58  
Italiano Tel: +49 (0) 180-534 16 80

**National Semiconductor Hong Kong Ltd.**

19th Floor, Straight Block,  
Ocean Centre, 5 Canton Rd.  
Tsimshatsui, Kowloon  
Hong Kong  
Tel: (852) 2737-1600  
Fax: (852) 2736-9960

**National Semiconductor Japan Ltd.**

Tel: 81-043-299-2308  
Fax: 81-043-299-2408

National does not assume any responsibility for use of any circuitry described, no circuit patent licenses are implied and National reserves the right at any time without notice to change said circuitry and specifications.